

THE PROPERTY OF THE DRAWING IS ESTABLISHED BY LAW. IT IS FORBIDDEN TO PRODUCE OR SHOW IT TO THIRD PARTY, WITHOUT A WRITTEN AGREEMENT.

Item	Name	Q.ty
1	05.02.001.06	2
2	M.12X81.5	1
3	R.20.SCH	2
4	SDR.2050.01.14	1
5	SDRG.2050.02	1
6	VSN.20.1.14	1

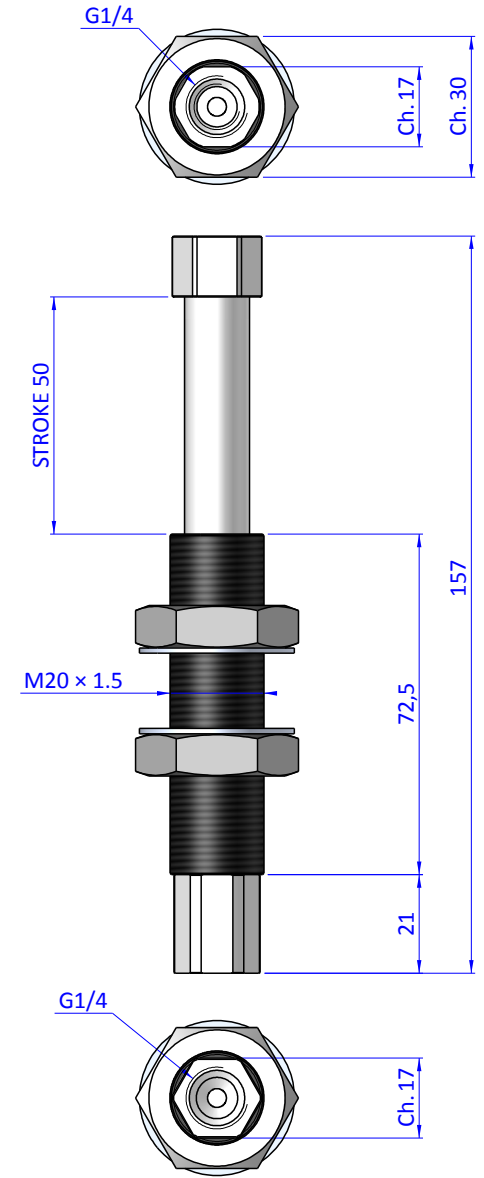
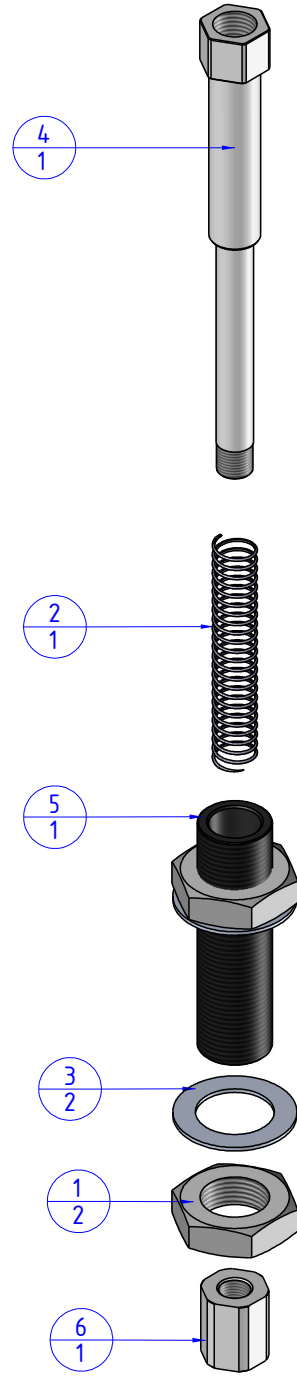

Format A3
UNI 936-76

		DESIGNED FROM	REVIEW
		FP SERVICES	A
GENERAL TOLERANCE	DESCRIPTION	DATE	WEIGHT
UNI - ISO 2768	CA.SDRG.2050.14	24/10/2018	0,110kg
CLASSE f		CODE	
			CA.SDRG.2050.14